

Farr High School



NATIONAL 4 PHYSICS

Unit 1 Electricity and Energy

Revision Notes

Content

Practical electrical and electronic circuits

- Measurement of current, voltage and resistance using appropriate meters in series or parallel circuits.
- Identification and use a range of electrical and electronic components to construct practical electronic circuits and systems.
- Current and voltage relationships in a series circuit.
- Practical applications of series and parallel circuits.
- Qualitative factors that affect resistance. Use of the appropriate relationships between voltage, current and resistance in calculations for series circuits.

Electrical power

- Electrical power as a measure of the energy transferred electrically by an appliance every second.
- Power consumption of different appliances, qualitative and quantitative.
- Use of the appropriate relationship between power, energy and time to justify energy saving measures.
- Energy efficiency as a key factor in energy generation, distribution and use.
- Calculation of efficiency given input and output power/energy.

Electromagnetism

- Relationship between electricity and magnetism.
- Practical applications of magnets and electromagnets

Generation of electricity









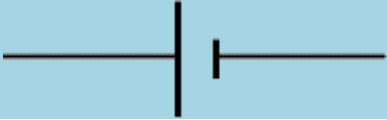
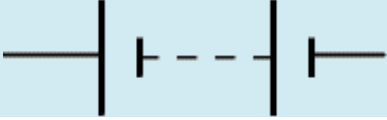
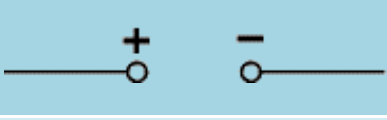
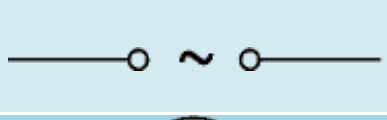

- Advantages and disadvantages of different methods of electricity generation and distribution.
- The potential role of different methods of electricity generation in future sustainable energy supply.
- The concept of energy efficiency and energy efficiency issues related to generation, distribution and use of electricity.

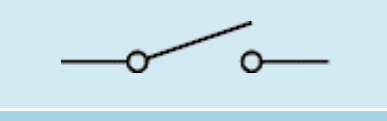

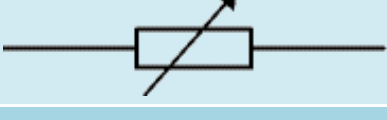
Gas laws and the kinetic model

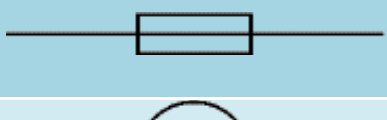
- Kinetic model of a gas.
- Applications of the kinetic model of a gas using knowledge of pressure, volume and temperature (for a fixed mass of gas).

Practical electrical and electronic circuits

Components and Symbols

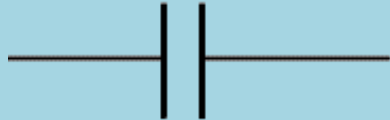
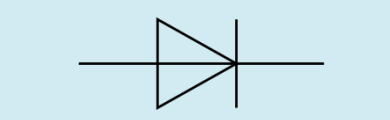
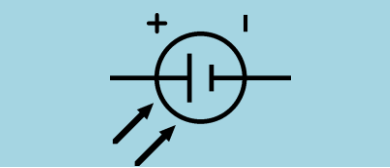
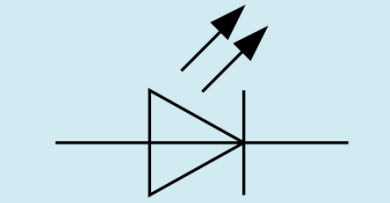
Component Name	Circuit Symbol	Function
Cell		Supplies electrical energy to a circuit, the longer line shows the positive side.
Battery		A battery of cells means 2 or more cells.
DC Supply		Supplies electrical energy to a circuit in the form of a direct current.
AC Supply		Supplies electrical energy to a circuit in the form of an alternating current.
Lamp		A lamp lights when current flows through it, converting electrical energy to light energy.
Switch		A switch allows you to complete or break a circuit.
Resistor		A resistor restricts the flow of current, this may be to protect other components.
Variable Resistor		A resistor, the resistance of which can be varied in the circuit, could be used for a dimmer switch.
LDR (Light Dependent Resistor)		Can be used to control a circuit. The resistance goes down as the light increases.
Thermistor		The resistance of a thermistor will increase as the temperature increases.
Fuse		A fuse is a safety device – the metal core will melt when too much current is flowing in the circuit.
Voltmeter		Must be placed in parallel to measure the difference in electrical potential between two points.
Ammeter		Must be placed in series to measure the current flowing in a circuit.
Ohmmeter		Measures resistance. Must be placed in parallel with the component(s) which are to be measured.

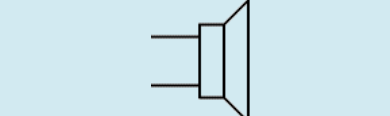
Capacitor		Used to store electrical charge, can be used to create a simple timing circuit, or in the flash in a camera.
Diode		Only allows current to flow in one direction.
Photovoltaic Cell		Converts light energy to electrical energy, can be used as the power source in a circuit. More light will mean a greater p.d. across the cell.
LED (Light Emitting Diode)		Emits light when a current flows but only allows current to flow in one direction. Requires less energy than a lamp.
Motor		Converts electrical energy into kinetic energy by turning.
Loudspeaker		Converts electrical energy into sound energy.

Electric Charge

There to be **two types of electric charge, positive and negative**. Through experimentation it is found that **like charges repel and unlike charges attract**.

A rod can be charged by rubbing. Depending on the materials used, the rod can either gain electrons and become negatively charged, or lose electrons and become positively charged. When brought close to a neutral item, this can cause the charges to be rearranged to give an imbalance on each side.

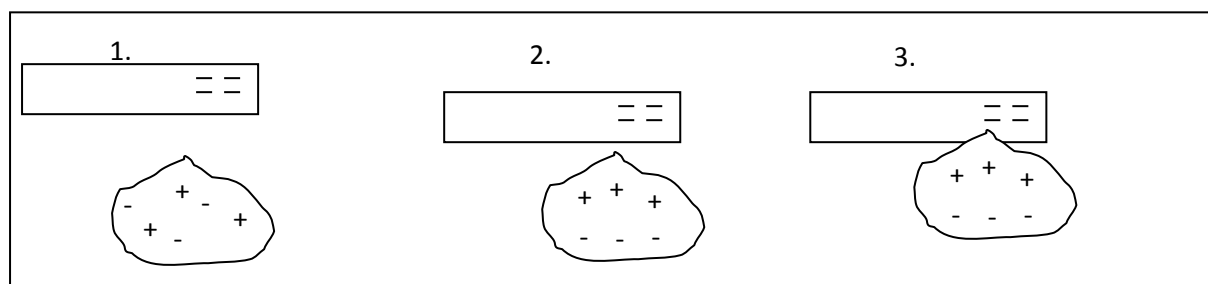

1. The charges on the piece of paper are evenly distributed amongst the piece of paper.
2. When the negatively charged rod is brought near, the positive charges are attracted and the negative charges repelled.
3. This imbalance of charge allows the rod to pick up the piece of paper.

NOTE:- Only the negative charges (electrons) can move. The positive charges are held tightly in the nucleus of the atoms.

Series and Parallel circuits

Series Circuits

In a series circuit there is only one path for the current to flow.

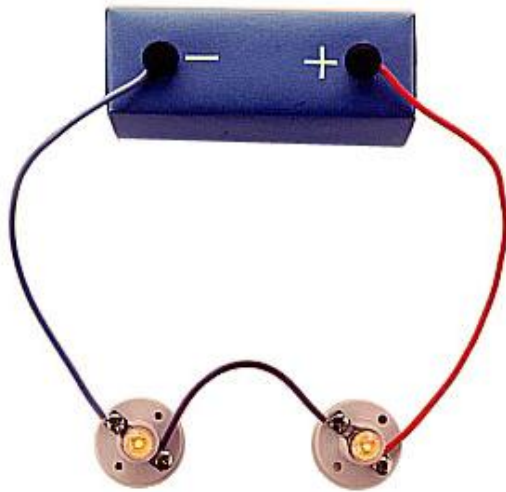

Parallel Circuits

In a parallel circuit there is *more than one path* (called a **branch**) for the current to flow.



Series circuit rules:

$$\mathbf{I_s = I_1 = I_2 = I_3 = I_4...}$$

Where I_s is equal to the total current of the supply – in a series circuit, the current is the same at ALL points in the circuit.

$$\mathbf{V_s = V_1 + V_2 + V_3...}$$

Where V_s is equal to the voltage of the supply – the Voltage of the supply is split across the different components in the circuit.

Parallel circuit rules:

$$\mathbf{V_s = V_1 = V_2 = V_3 = V_4...}$$

Where V_s is equal to the supply voltage – in a parallel circuit, the voltage is the same across all branches in the circuit.

$$\mathbf{I_s = I_1 + I_2 + I_3...}$$

Where I_s is equal to the supply current – the supply current is split across the different branches in the circuit.

Resistance in a series circuit

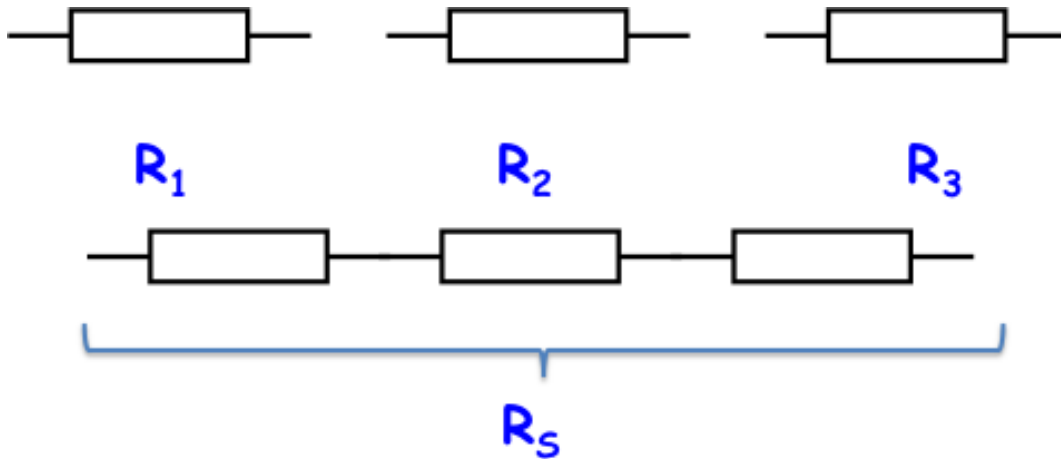

If we join components in series we **increase the resistance** of the circuit

The current will **decrease**

The total resistance in series is equal to the sum of the individual resistances:

$$R_s = R_1 + R_2 + R_3$$

Worked Example:

If in the above diagram R_1 and R_2 have a resistance of 4Ω , and R_3 has a resistance of 2Ω , what is the total resistance of the three of them together?

Solution:

$$R_s = R_1 + R_2 + R_3$$

$$R_1 = R_2 = 4 \Omega$$

$$R_s = 4 + 4 + 2$$

$$R_3 = 2 \Omega$$

$$\underline{R_s = 10 \Omega}$$

$$R_s = ?$$

Ohm's Law

- Electrical conductors allow a current to flow through them **easily**
- Electrical insulators **do not easily** allow a current to flow through them

Another way of stating this is that conductors have a low **resistance** to electrical current whilst insulators have a high resistance.

The resistance of a material is a measure of how well it allows electric current to pass through it.

Resistance restricts the flow of charge, so a resistance makes the current smaller.

Ohm's Law Experiment

The equipment was set up as below. The voltage was altered by changing the variable power supply and the current was measured.

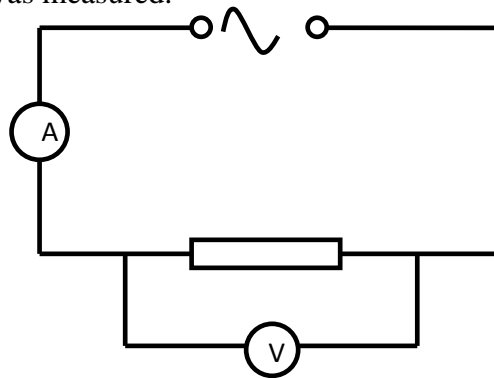

The experiment showed the following graph:

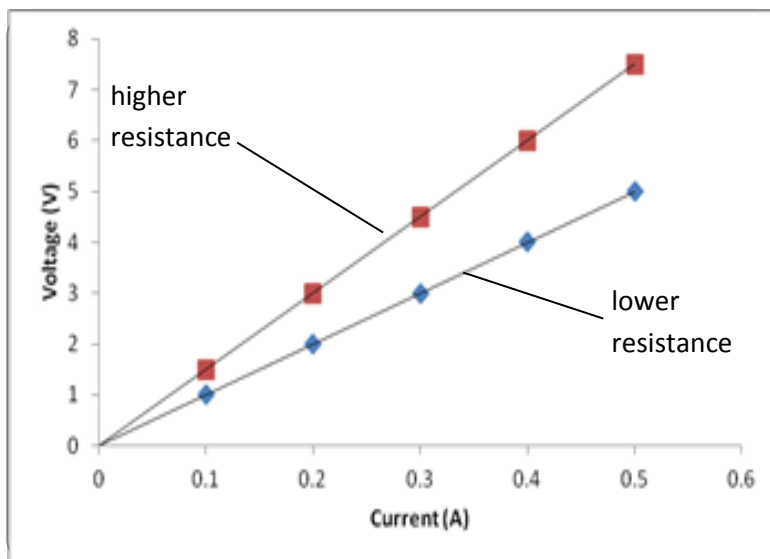

The relationship between the resistance of a conductor, the voltage across it and the current through it is $R = \frac{V}{I}$ which is often shown as $V = IR$.

This relationship is known as Ohm's Law. It states that the current through a conductor is directly proportional to the potential difference across it. The resistance of a conductor stays constant regardless of the potential difference across it.

The steeper the gradient of a best-fit line on a V-I graph the greater the resistance.

Using Ohm's Law

We saw that the relationship between voltage, current and resistance was given by $V=IR$
We will be using that relationship to tackle the following problems

Worked Example:

What is the potential difference across a resistor if its resistance is 470Ω and the current through it is 0.21 A

Solution:

$$V = I \times R$$

$$\text{Current, } I = 0.21 \text{ A}$$

$$V = 0.21 \times 470$$

$$\text{Resistance, } R = 470 \Omega$$

$$\underline{V = 98.7 \text{ V}}$$

$$\text{Voltage, } V = ?$$

What affects Resistance?

The Resistance of a Filament Bulb

As the bulb got brighter, its resistance increased.

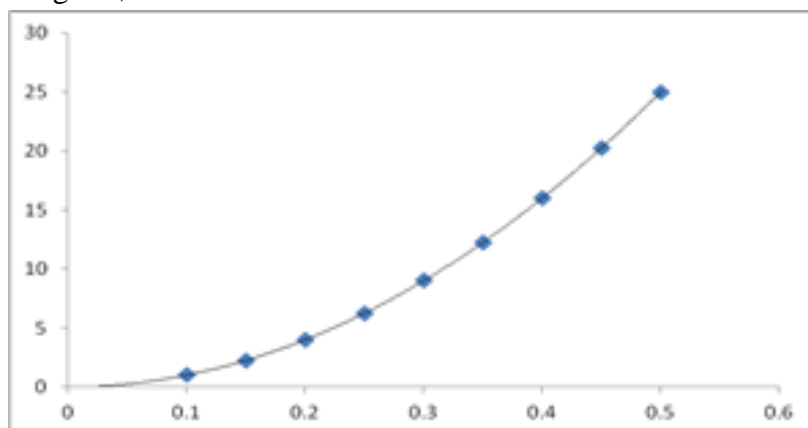

For low current values, when the bulb would have been cold the relationship between V and I is almost a straight line. However the gradient increases sharply as the current, and therefore the temperature, increased. This indicates that **as the temperature of a conductor increases, its resistance increases**

Conducting Wire

If we look at a conducting wire the resistance depends on several factors:

- **Length** – the longer the wire, the greater the resistance
- **Thickness** – the larger the cross-sectional area of a wire the smaller its resistance:
- **Material** from which the wire is made (e.g. copper wires have low resistance and are used as connecting wires)

Logic Gates

There are different types of logic gate, depending upon what the gate is needed to do.

OR gates



An OR gate will give a high output if any of the inputs is high. In other words, there only needs to be an input in A **OR** B for there to be an output at Q.

AND gates

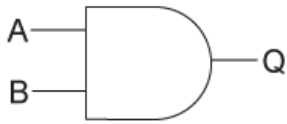

An AND gate will give a high output only if all of the inputs are high. In other words, there is only an output if there is an input in A **AND** B.

NOT gates

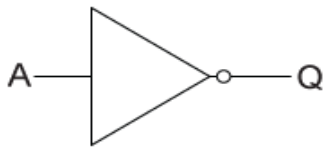

A NOT gate is slightly different because it has just one input. It will give a high output if the input is low. This could be represented by a simple lighting circuit with a push-to-break switch: if the switch is pressed then the lamp will turn off. NOT gates are often used in emergency-stop buttons on machine tools.

Electrical Power

When we are using electrical appliances, it is useful to have an idea of how much energy they will require. This leads to the definition of electrical power.

Power is defined as the amount of energy transformed per second, as shown in the equation below

$$P = \frac{E}{t}$$

Symbol	Name	Unit	Unit Symbol
P	Power	watts	W
E	Energy	joules	J
t	time	seconds	s

Different appliances will transform more or less electricity. Often the highest powered ones will be those which transform electrical energy into heat energy, for example a hair dryer. We often describe this as the power consumption.

Appliance	Power transformation/W
Oven	3000
Dishwasher	1400
Iron	1100
Hair Dyer	1500
Microwave	1000
TV	250
Stereo	60
Filament Lamp	100
Energy Saving Lamp	11
Drill	750
Fridge	1400

The higher the power rating, the more energy which has been transferred.

Worked examples

1. What is the power of a television which transforms 0.5 MJ of energy in 1 hour?

$$\begin{aligned} P &= ? & P &= E/t \\ E &= 0.5 \text{ MJ} & P &= 0.5 \times 10^6 / 3600 \\ t &= 1 \times 60 \times 60 = 3600 \text{ s} & P &= 139 \text{ W} \end{aligned}$$

2. A 1500 W hairdryer is used for 5 minutes, how much energy is transformed?

$$\begin{aligned} P &= 1500 \text{ W} & P &= E/t \\ t &= 5 \times 60 = 300 \text{ s} & 1500 &= E/300 \\ E &= ? & E &= 1500 \times 300 \\ & & E &= 450000 \\ & & E &= 450 \text{ kJ} \end{aligned}$$

Efficiency

Efficiency is a measure of how well something works, usually expressed as a percentage.

Energy efficiency is calculated using:

$$\% \text{ Efficiency} = \frac{\text{Useful Energy}}{\text{Energy}} \times 100$$

Power efficiency is calculated using:

$$\% \text{ Efficiency} = \frac{\text{Useful Power}}{\text{Power}} \times 100$$

Example:

A power station is supplied with 100MJ of energy from the fuel. The output energy is 80MJ.

Calculate the efficiency of the power station.

$$\% \text{ Efficiency} = \frac{\text{Useful Energy}}{\text{Energy}} \times 100$$

$$\% \text{ Efficiency} = \frac{80 \times 10^6}{100 \times 10^6} \times 100$$

$$\% \text{ Efficiency} = 80\%$$

Electromagnetism

Magnetic Fields

All magnets have a North and a South pole. A bar magnet has poles at both ends. All magnets have a magnetic field which attracts some metals towards the magnet. It can also pull or push away other magnets.

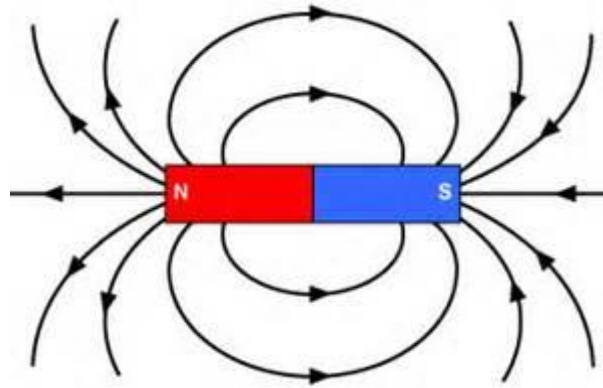

Magnetic Field Around Bar Magnet

The North poles together repel one another, but if a North and South are brought together, they attract one another.

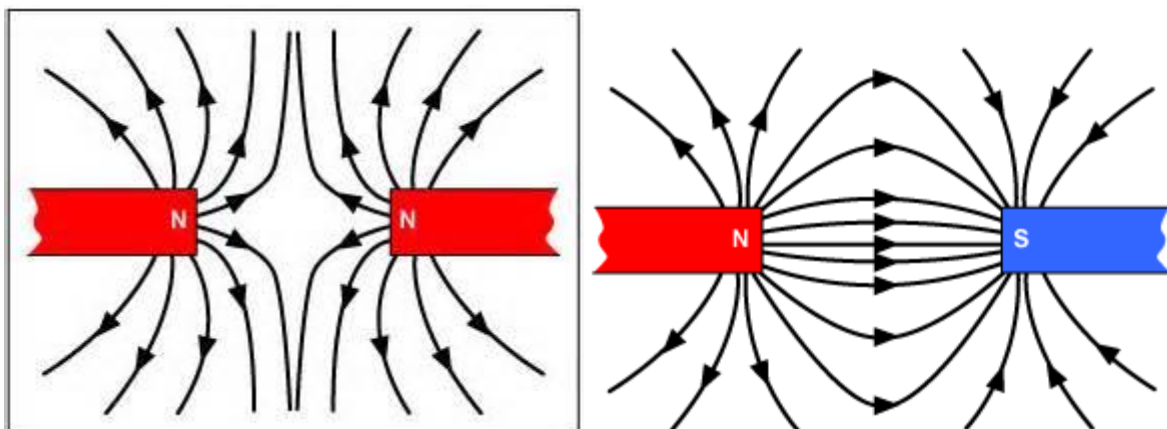

Electromagnets

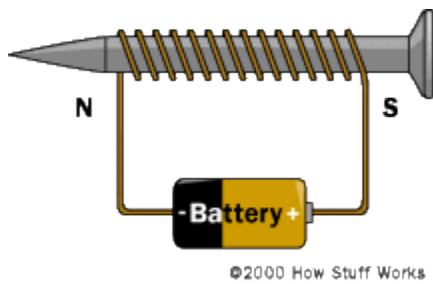

Permanent magnets cannot be turned off. An electromagnet can be switched on and off. A length of wire is wrapped around a metal nail. The current which flows through the wire causes a magnetic field around the nail which is similar to that of a bar magnet.

You can increase the magnetic field produced by increasing the number of turns of wire, increasing the current and winding the coil on a metal core.

Practical Applications of Magnets and Electromagnets

Solenoid



When a current flows through the coil of wire in the body of the solenoid it creates a magnet. This repels the pin in the centre of the solenoid.

This is a magnetic switch. It can be used in central locking in a car or to switch on/off the water valve in a washing machine.

Electric Bell

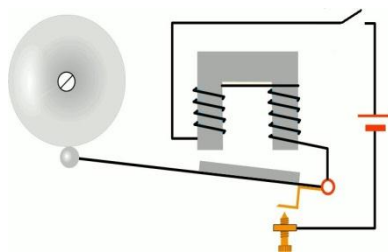

When the school bell rings it depends on an electromagnet. When the circuit is closed the magnet created attracts the piece of steel on the hammer, which strikes the bell when it moves up. As it moves up the circuit is broken so that the magnet no longer works.

The piece of steel cannot stick to the electromagnet because it is off, and returns to its original position because it is springy.

When it is back where it started the circuit is complete again and the cycle repeats.

Relay

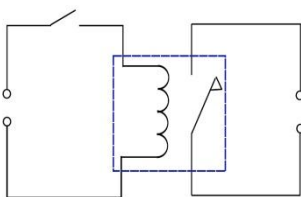

The coil in the left hand circuit becomes a magnet when the switch closes to make the circuit complete.

This attracts the switch in the second circuit to close, turning on whatever is in the second circuit.

The two circuits are NOT joined and can use different voltages.

Motor

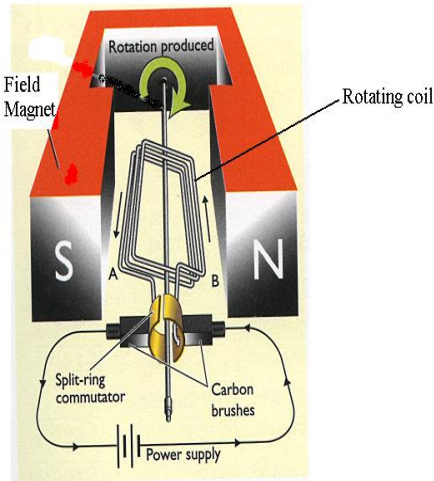

A motor depends on the interaction between two magnetic fields. The coil in the centre of the motor is an electromagnet. When current flows through the rotating coil its magnetic field interacts with the field from the field magnet (which can be permanent or an electromagnet).

Where there are like poles the rotating coil is repelled. This makes it spin.

The commutator makes current flow in the correct direction to keep the motor spinning. The brushes allow the current to reach the commutator.

Commercial motors use more than one rotating coil in the centre and usually have electromagnets for the field magnet.

This means that commercial motors rotate more smoothly than a simple motor.

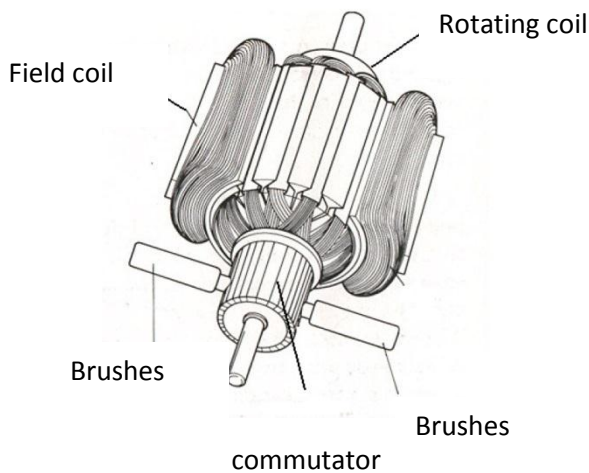

Generation of Electricity

Renewable and Non-Renewable Energy

The energy we use can come from lots of different sources. We can divide these sources up in to two groups – renewable and non-renewable energy.

Renewable Energy Sources	Non-Renewable Energy Sources
Wind	Coal
Wave	Oil
Tidal	Gas
Solar – Cells and Panels	Nuclear (Uranium + other radioactive materials)
Biomass	Peat
Geothermal	
Hydroelectric	

Thermal Power Stations

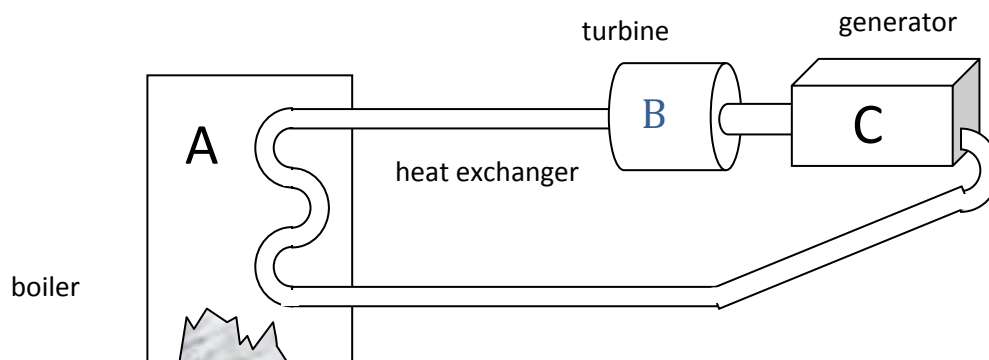

In a thermal power station we burn fuel to produce heat.

The energy changes at each part of the process are –

A	Chemical energy in the fuel is converted to heat as the fuel burns. This is used to turn water into steam in the pipes of the heat exchanger.
B	Steam turns the blades in the turbine. Heat energy -> kinetic Energy
C	The turbine turns the generator, producing electricity. Kinetic energy -> electrical energy

Energy Sources - Advantages and Disadvantages

	Energy Source	Advantages	Disadvantages
Non-Renewable	Coal, Oil, Gas, Peat	Plentiful in some areas	CO ₂ , SO ₂ pollution. Expensive
	Nuclear	No CO ₂ , SO ₂ pollution. Large amount of energy for amount of fuel used.	Radioactive waste needs long term storage. People worry about nuclear safety
Renewable - All clean, all 'free'	Solar	Still available on dull days	Not available at night
	Wind	Wind available everywhere	Unpredictable.
	Wave	Huge amount of energy	Unpredictable
	Tidal	Predictable, reliable	Better in some areas than others
	Biomass	Can use waste products	Growth too slow to use.
	Geothermal	Most areas can provide small amounts	Best in places with 'hot rocks' like Iceland.
	Hydroelectric	Reliable. Can be used as storage	Needs particular geography. Uses up land, can create methane

Transformers

When electricity is generated and distributed it is important that this is done as efficiently as possible so that energy is not 'lost'.

One way this is done is to use a transformer.

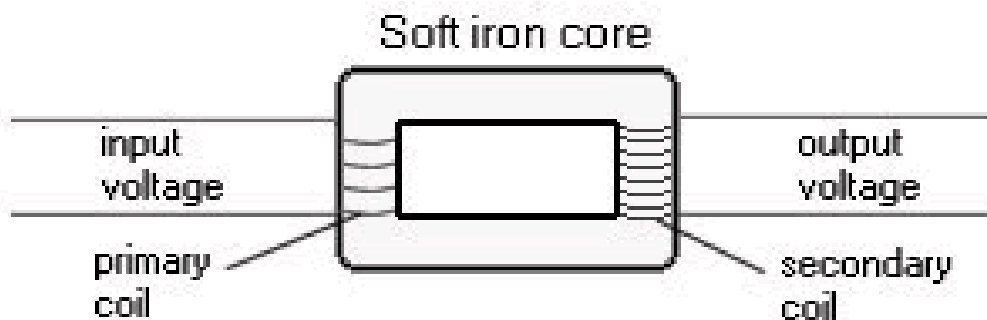

A transformer is used to increase or decrease voltages.